

Data Sheet



Article number: 0118034

Description: Retaining ring H 18

Measures

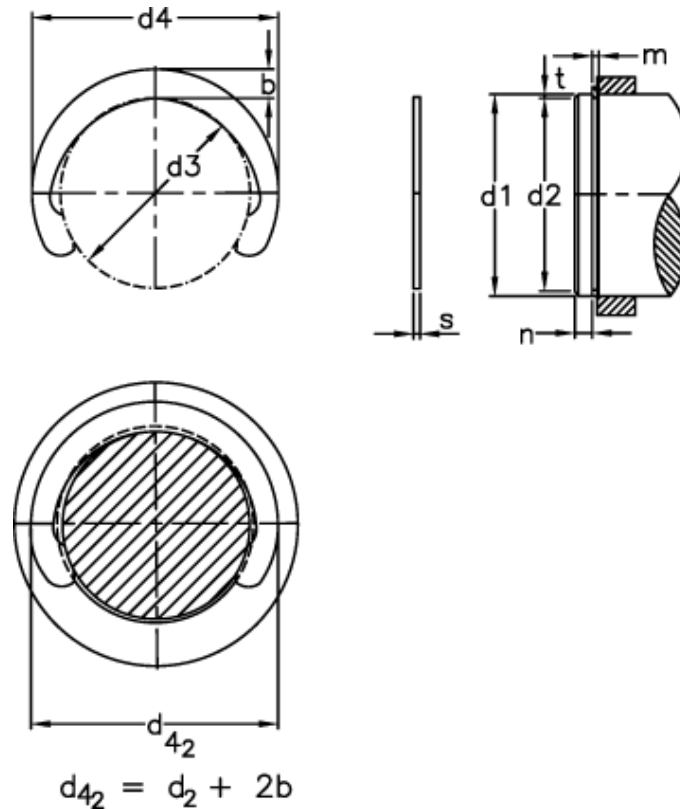

b	= 2.30	FRg kN	= 2.8	t	= 0.85
d1	= 18	FR kN	= 8.50	tol	= -0.11
d2	= 16.3	g	= 1.20	tol	= 0.18
d3	= 15.80	Gripper	= GRH 18	tol	= -0.06
d4	= 20.40	m min	= 1.30	Weight kg/1000	= 0.72
d4 2	= 20.9	n abl x 1000	= 21		
Description	= H 18,0	Nominal drive	= 2.6		
FN kN	= 3.70	s	= 1.20		